

PFB303W

Wall Mount Bracket



Features

- Material: Aluminum
- Wall Mount Bracket
- Neat & Integrated design

Specifications

Model	PFB303W
General	
Material	Aluminum
Dimension (W x H x D)	115mm x 160mm x 255mm
Pipe Thread	G1 1/2"
Operating Temperature	-40°C ~60°C
Humidity	0~90% RH
Load Bearing	7.0Kg
Weight	0.66Kg
Applicable Model	Please see "Accessory Selection"

PFB303W

Dimensions (mm)

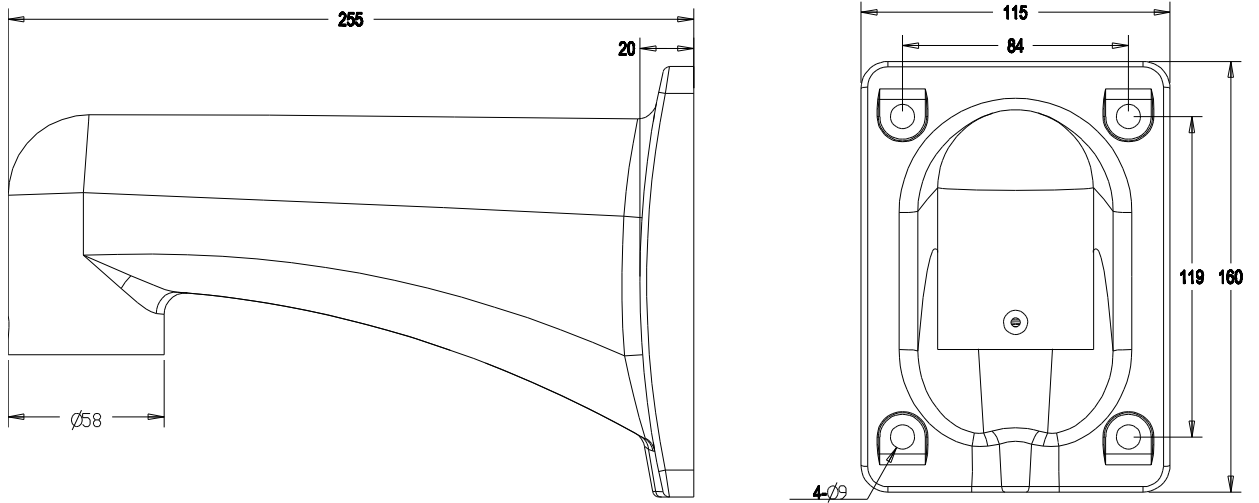

Application

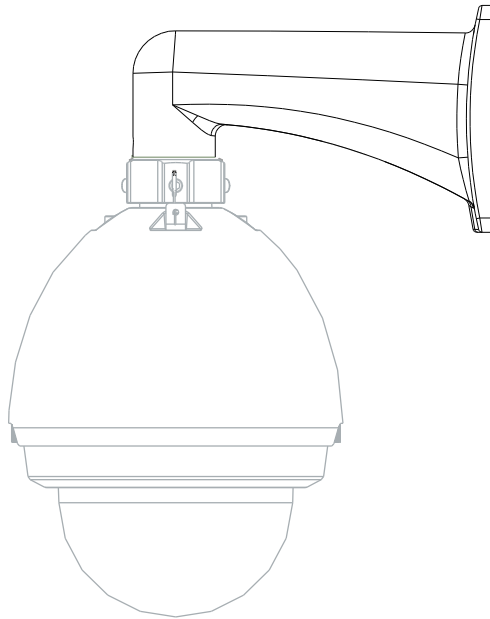

Dahua Technology Co., Ltd.

1199 BinAn Road, Binjiang District, Hangzhou, China

Tel: +86-571-87688883

Fax: +86-571-87688815

Email: overseas@dahuatech.com

www.dahuasecurity.com

*Design and specifications are subject to change without notice.

© 2014 Dahua Technology Co., Ltd.